

FUSIONTOW

60" LIGHTBAR



FN-0320

INSTRUCTION MANUAL



Fenix Product Copyrights This price List and the mentioned Fenix products include or describe copyrighted Fenix material. Laws in the United States and other countries preserve for Fenix Industries and its licensors certain exclusive rights for copyrighted material, including the exclusive right to copy, reproduce in any form, distribute and make derivative works of the copyrighted material. Accordingly, any copyrighted material of Fenix and its licensors contained herein or in the Fenix products described in this Price List may not be copied, reproduced, distributed, merged or modified, transmitted, transcribed, stored in retrieval system or translated into any language or computer language, in any form or by any means, without prior written permission of Fenix Industries, Inc.. Fenix and the stylized Fenix logo are registered in the U.S. Patent & Trademark Office.



TABLE OF CONTENTS



Safety Regulations & Warranty	3
Service after Expiration	3
Copyright	3
Fenix Product Copyright	3
Specifications, Flash Patterns, & Wiring	4
Specifications	4
Flash Patterns	4
Box Contents	4
Mount Kits	4
Dimensions	4
Wiring & Functions	5
Wiring Diagram	5
Power Connection	5
Warning Modes	5
Work Light/Pattern Selection Modes	5
Flash Pattern Selection	5
Work Lights	5
Cruise Mode	5
Mounting Straps & Brackets	6
Vehicle Specific Hook Mounts	6
Universal Mounts	6
Hook Kit Installation	7

SAFETY REGULATIONS & WARRANTY

SAFETY REGULATIONS

The following provides all the information necessary to safely operate the previously listed products of Feniex Industries, Inc. Please read this manual thoroughly before installing or operating your new product in order to prevent any damage or injury. Failure to follow the listed instructions in this manual may result in damage to your products or personal injury.

- Proper installation of this product requires good knowledge of automotive systems, electronics & procedures.
- Please guarantee all vital components of the vehicle are not in danger of being damaged by drilling holes necessary for installation. Check all sides of the mounting surface before drilling any holes into the vehicle.
- Do not install this product in any way that interferes with the deployment of the air bag. Doing so may damage the effectiveness of the air bag & can lead to serious personal and vehicle injury. The installer will assume full responsibility of proper installation of the new unit.
- Please clean the mounting surface before installation of the unit when using tape, brackets, magnet, Velcro or suction cups.
- The product's ground wire must be connected directly to the negative (-) battery post for effective use of the unit. Please follow all wiring guidelines provided to guarantee long lifespan & productivity. Failing to follow these instructions may result in damage to the product.

WARRANTY

Feniex Industries, Inc. warrants to the original purchaser that the product shall be free from defects in material & workmanship for 5 years from the date of purchase for all LED products. Feniex Industries warranties speakers, sirens, flashers, & controllers for 2 years.

If warranty service is needed, please contact customer support:

Phone: 1.800.615.8350

Web Site: www.Feniex.com/support

Email: techsupport@feniex.com

If the product needs to be returned for repair or replacement, contact our customer service team (using any method listed above) to receive a Return Merchandise Authorization (RMA) number. Operational times are from 9 a.m. to 6 p.m. central time, Monday through Friday.

 Please do not send in product without contacting support first for a Return Merchandise Authorization (RMA) number.

CONDITIONS

Feniex Industries, Inc. will not be held responsible for any costs associated with equipment removal and/or re-installation resulting from a warranty claim. It is the sole responsibility of the party initiating a warranty claim to pay shipping charges associated with returning a product to Feniex Industries for repair or replacement.

SERVICE AFTER EXPIRATION

Feniex Industries will still provide service for all products after expiration of the warranty. For any issues, call the customer support line. In some instances it may be necessary for the product to be shipped, freight prepaid and insured for loss or damage to Feniex headquarters.

 Utilizing non-factory screws and mounting brackets may result in the loss of warranty coverage.

COPYRIGHT

This instruction manual and the Feniex products described in this instruction manual may include or describe copyrighted Feniex material. Laws in the United States and other countries preserve for Feniex Industries and its licensors certain exclusive rights for copyrighted material, including the exclusive right to copy, reproduce in any form, distribute and make derivative works of the copyrighted material. Accordingly, any copyrighted material of Feniex and its licensors contained herein or in the Feniex products described in this instruction manual may not be copied, reproduced, distributed, merged or modified in any manner without the express written permission of Feniex Industries, Inc.

FENIEX PRODUCT COPYRIGHTS

The products described in this document are the property of Feniex Industries, Inc. It is furnished by express license agreement only and may be used only in accordance with the terms of such an agreement. Products and documentation are copyrighted materials. Making unauthorized copies is prohibited by law. No part of the product or documentation may be reproduced, transmitted, transcribed, stored in retrieval system or translated into any language or computer language, in any form or by any means, without prior permission from Feniex Industries, Inc.

SPECIFICATIONS, PATTERNS, & WIRING

SYSTEM SPECIFICATIONS

Input Power	12-18 Volts DC
Current Draw	15 Amps
External Fuse	125% of Circuit Load
Cable	15 Feet
Colors	Amber, Red, Blue, White, Green
SAE Certification	Meets or Exceeds Class 1
Flash Patterns	12
LED Technology	Cree, 4 Watt
Dimensions	59.5" L x 1.6" H x 11.8" W
Warranty	5 Years

FLASH PATTERNS

- 1) Cluster
- 2) Attack
- 3) Half-Half [Slow]
- 4) Half-Half [Fast]
- 5) All-On [Slow]
- 6) All-On [Fast]
- 7) Alternating Half-Half [Slow]
- 8) Alternating Half-Half [Fast]
- 9) Cruise Corners
- 10) Cruise All Steady On
- 11) Quad Half-Half
- 12) Quad Inside-Outside

BOX CONTENTS



BOX CONTENTS	QUANTITY
1. Fusion TOW 60" Lightbar	1
2. Standard Foot Mount	2*

*Permanent or Headache Rack Mounts may be substituted at time of purchase

MOUNT KITS*	PART NUMBER
Standard Foot Mount	FN-9716-M-F*
Permanent Mount	FN-9916-M-P*
Headache Rack Mount	FN-9816-M-H*
Adjustable Foot Mount	FN-9927-AF*

*Sold Separately, in pairs

! See page 6 for a full list of available vehicle specific lightbar strap kits.

DIMENSIONS

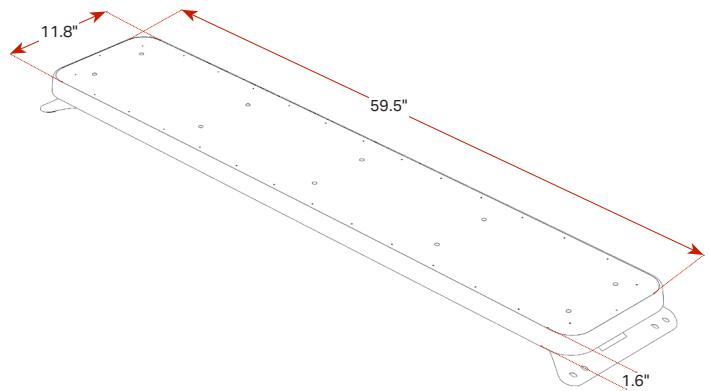

All user-supplied wires connecting to 12v (+) or 12v (-) must be sized to supply 100% of the maximum current and properly fused at the power source with a fuse rated at 125% of the total circuit load. Avoid routing wires in the deployment area of the vehicle air bag or any other potentially hazardous locations.

WIRING DIAGRAM: STANDARD CONFIGURATION

Wire Color	Function	Polarity	Description
Black	Ground	12v (-)	Connect to vehicle's negative battery post
Red	Positive	12v (+)	Connect to vehicle's positive battery post
Brown	Mode 1	12v (+)	Mode 1 Activation (All Positions)
Green	Mode 2	12v (+)	Mode 2 Activation (All Positions, Overrides Mode 1)
Yellow	Work Light/Pattern	12v (+)	Programmable, Work Light Activation or Pattern Changer
White	Tail Lights	12v (+)	Activates Tail Light function (if equipped)
Blue	Left Brake Light	12v (+)	Activates Left Brake/Turn function (if equipped)
Gray	Right Brake Light	12v (+)	Activates Right Brake/Turn function (if equipped)

The yellow wire is user-programmable between work light activation and pattern changer. See below for programming instructions.

POWER CABLE WIRING

- 1) Install a customer-supplied fuse rated for 125% of the circuit load to the end of the red wire. Do not use a circuit breaker or fusible link.
- 2) Connect the opposite end of the fuse to the 12v+ terminal of the battery. Do not use more than 1 foot of wire between the fuse and the battery terminal to ensure appropriate protection.
- 3) Connect the black wire to the vehicle chassis ground.
- 4) Connect the function wires to switches, depending on the functions needed for applications (See chart above).

WARNING MODES

Activate the warning modes by extending the blue/white (front) and green/white (rear) wires to 12v (+) latching switches to activate mode 1 (front and/or rear as desired). When power is supplied to mode 2 (black), the pattern will be changed for the active display. When power is supplied to Mode 3 (red) or mode 4 (orange) wires, the selected pattern for each mode will display on the whole bar (front and rear).

WORK LIGHT OR PATTERN SELECTION MODE

To toggle between the yellow wire activating either work light mode or pattern selection mode, do the following:

1. Apply 12v (+) to the red wire.
2. Within 5 seconds after connecting the red wire, tap the yellow wire 5 times to the 12v (+).
With each tap, the work lights should activate and on the 5th tap the work lights will turn off by themselves.
3. The yellow wire is now the pattern changer wire. This will only work with only the red wire is activated to a 12v (+)

FLASH PATTERNS

While the yellow wire is programmed for pattern selection mode, advance the pattern applying 12v (+) for 1 second. Continue to do this until the desired pattern is displayed.

WORK LIGHTS

While the yellow wire is programmed for work light activation mode, apply 12v (+) to activate the work lights.

CRUISE MODE

Cruise mode is available as a pattern. While either Mode 1 or Mode 2 is active, select pattern #14. This will set the active mode's pattern to "Cruise", which will display the corner and side modules @ 10% intensity.

MOUNTING STRAPS & BRACKETS

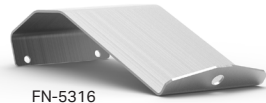

FN-5316

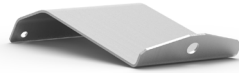

FN-5116

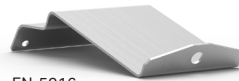

FN-5016

MAKE	MODEL	FROM	THROUGH	PART #
Chevrolet	Avalanche	2007	2013	FN-5016
Chevrolet	Caprice	2011	2017	FN-5316
Chevrolet	Colorado / Canyon	2015	2018	FN-5116
Chevrolet	2500 Heavy Duty	2014	2018	FN-5016
Chevrolet	Impala	2014	2018	FN-5316
Chevrolet	Malibu	2012	2016	FN-5316
Chevrolet/GMC	Silverado / Sierra	2014	2018	FN-5316
Chevrolet/GMC	Tahoe / Yukon / Suburban	2007	2014	FN-5016
Chevrolet/GMC	Tahoe / Yukon / Suburban	2015	2018	FN-5316
Chevrolet/GMC	Trailblazer / Envoy	2002	2009	FN-5016
Dodge	Charger	2011	2018	FN-5316
Dodge	Dakota	2005	2011	FN-5116
Dodge	Durango	2011	2018	FN-5116
Dodge	Ram 1500, 2500 & 3500	2012	2018	FN-5316
Ford	Escape	2013	2018	FN-5316
Ford	Excursion	2000	2006	FN-5316
Ford	Expedition	2007	2017	FN-5316
Ford	Explorer / Police Interceptor	2013	2018	FN-5316
Ford	F-150	2015	2018	FN-5316
Ford	F250, F350, F450	1999	2016	FN-5316
Ford	Fusion / Police Hybrid	2013	2019	FN-5316
Ford	Ranger	1998	2011	FN-5016
Ford	Taurus / Police Interceptor	2013	2018	FN-5316
Universal	Universal	N/A	N/A	FN-5316

UNIVERSAL BRACKETS	PART #
Headache Rack Mount	FN-9816-M-H*
Permanent Mount	FN-9916-M-P*
Adjustable Foot Mount	FN-9927-AF*
Standard Foot Mount	FN-9716-M-F*

*Sold in pairs

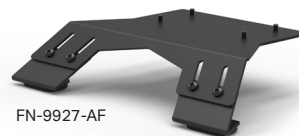

FN-9927-AF



FN-9716-M-F



FN-9816-M-H



FN-9916-M-P

HOOK KIT INSTRUCTIONS

INSTALLING A HOOK BRACKET

- 1) Remove the hex bolt from its packaging and slide the bolt through the hook bracket hole. See figure A.
- 2) Using a socket wrench and the hex bolt, loosely secure the hook bracket to the threaded hole in foot bracket. Repeat on the other side of the lightbar so both sides have the hook bracket secured. See figure B.
- 3) Place the lightbar with the attached hook brackets on the vehicle. Ensure the hook bracket is up right and seated correctly. See figure C.
- 4) Secure and tighten the bracket using a socket wrench on each side of the vehicle until the bar is snugly mounted. Use the included lock nut as a jam nut for extra security. Ensure the vehicle's door will close without any interference.

! Do not overtighten the hex bolts. Do not exceed 165 in. lb. The use of blue thread locker is suggested.

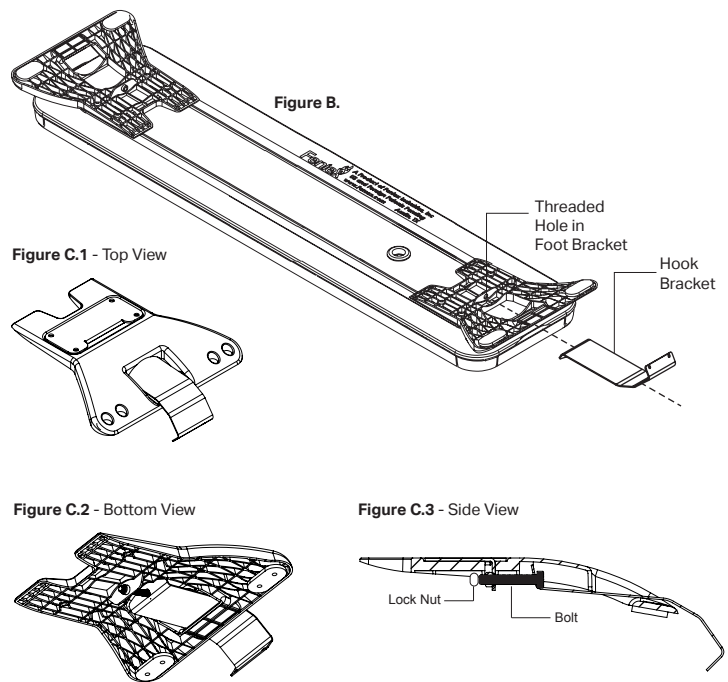
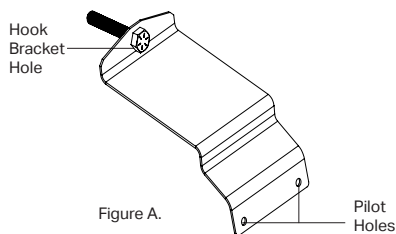

! Use the "Hook Kit Compatibility Chart" for more information on page 8 of this manual.

- 5) Drill and secure the bracket to the vehicle with self-tapping screws using the two pilot holes on the bottom of the hook bracket as a guide.
- 6) Once the bar is secure, drill a one-inch hole to route the wire harness through the vehicle and then seal the hole with silicone. Ensure that wires are protected from rough edges using a rubber wire grommet.

! Utilizing non-factory hardware and mounting brackets may result in loss of warranty coverage.